



SAMSUNG



DIGITAL VIDEO RECORDER

SHR-1040/SHR-1040K User's Manual

English

Français

Spanish

Safety Regulations

Please be sure to keep the following in mind for the right use of the product to pre-vent proprietary risk or damage.

- **Do not use multiple plugs at once.**
 - This may cause abnormal heat generation or fire
- **Do not put a vase, flowerpot, cup, cosmetics, medicine, or vessel with water around you.**
 - This may cause fire.
- **Do not bend the power cord forcibly nor put a heavy material on it.**
 - This may cause fire.
- **Do not touch the power plug with wet hands.**
 - This may cause electric shock.
- **Insert the power plug firmly enough not to shake.**
 - This imperfect connection may cause fire.
- **Keep the product off humidity, dust, or soot.**
 - This may cause fire or electric shock.
- **Do not put metals(coin, hair pin, metal piece, etc.) or inflammable materials(match, paper, etc.) in the ventilation hole.**
 - This may cause fire.
- **Keep the surrounding temperature between 32°F to 104°F and keep the product off humidity.**
 - This may cause breakdown.
- **Secure sufficient ventilation.**
 - This may cause abnormal operation due to high temperature.
- **Keep the product off direct ray of light or heat from the heating device**
 - This may cause fire.
- **Do not disassemble, repair, or remodel the product.**
 - This may cause fire, electric shock, or injury due to abnormal operation.
- **Do not pull out the power cord.**
 - This may destroy the power cord, eventually, cause fire or electric shock.
- **Plug out in the event of thunder or lightning.**
 - This may cause fire.
- **Keep your children off the battery after you take it out of the product. They tend to swallow it unconsciously.**
 - If your children swallow it, please see the doctor immediately.
- **Install the product at a safe place or attach the product to the wall or ceiling with a stand firmly enough not to fall to the ground.**
 - This may injure people.



Before we start

This User's Manual describes the basic usage of SHR-1040.

This Manual contains all the matters necessary for using SHR-1040 such as brief instruction, part name, function, connecting other equipment, and menu setup of SHR-1040.

- SEC retains the copyright on this User's Manual.
- This User's Manual cannot be copied without SEC's prior written approval.
- We are not liable for any or all losses to the product incurred by your use of non-standard product or violation of User's Manual.
- If you want to open the system case to touch the inside, please consult with an expert who works for the shop where you bought the product.
- You may download open source codes from the following website.
(See CCTV Part of <http://www.sec.co.kr>)

WARNING

[Battery]

As wrong exchange of the battery in SHR-1040 may cause explosion, you shall use the certified battery for SHR-1040.

The battery specification is as follows.

- Normal Voltage : 3V
- Normal Capacity : 220mAh
- Continuous Standard Load : 0.2mA
- Operating Temperature : -22°F ~ +140°F

Standards Approvals



Note : This equipment has been tested and found to comply with the limits for a Class A digital device, pursuant to part 15 of the FCC Rules. These limits are designed to provide reasonable protection against harmful interference when the equipment is operated in a commercial environment.

This equipment generates, uses, and can radiate radio frequency energy and, if not installed and used in accordance with the instruction manual, may cause harmful interference to radio communications. Operation of this equipment in a residential area is likely to cause harmful interference in which case the user will be required to correct the interference at his own expense.

Contents

ii	Safety Regulations
iii	Before we start
	Standards Approvals
1	Chapter 1. Overview
1-1	1. Introduction
1-2	2. Features
1-3	3. Part Names and Functions
1-6	4. Remote Controller
2	Chapter 2. Installation
2-1	1. Installation Environment Setup
2-2	2. Checking Product & Accessory
2-3	3. HDD Addition
3	Chapter 3. DIY Camera
3-1	1. Standard Camera
3-5	2. Nightvision Camera
4	Chapter 4. Connecting with Other device
4-1	1. Connecting the Video, Audio, and Monitor
4-2	2. Connecting the Alarm Input/Output
5	Chapter 5. Basic Operation
5-1	1. System Operation
5-2	2. Live Screen Mode
5-3	3. Key Functions
5-3	3.1. Channel Key & Mode Key
5-3	3.2. Pip Key
5-4	3.3. Zoom Key
5-4	3.4. Freeze Key
5-5	3.5. Sequence Key
5-5	3.6. Alarm Key

6

- 6-1 1. Main Setup Menu
- 6-2 2. Clock/Display Setup
- 6-3 3. Record Mode Setup
- 6-4 4. Title Setup
- 6-5 5. Dwell Time Setup
- 6-6 6. Alarm Setup
- 6-7 7. Event Record Mode Setup
- 6-9 8. Timer Record Setup
- 6-10 9. System Setup
- 6-14 10. System Information

7

- 7-1 1. Basic Recording
- 7-1 2. Timer Recording
- 7-2 3. Motion Recording
- 7-2 4. Alarm Recording
- 7-3 5. Stop Recording

8

- 8-1 1. Search Menu
- 8-2 2. Date Time Search
- 8-2 3. Record Event Search
- 8-3 4. Alarm Event Search
- 8-3 5. Loss Event List
- 8-4 6. Power Event List
- 8-4 7. Basic Playback

9

- 9-1 1. Product Specification
- 9-4 2. Recommended HDD List
- 9-5 3. Outline Drawing

Chapter 6. Menu Setup

Chapter 7. Recording

Chapter 8. Search & Playback

Chapter 9. Appendix



Chapter 1. Overview

1 Introduction

The SHR-1040 digital video recorder is a digital video recorder that records and plays back video and audio input from four cameras. It records and plays back each channel of video data in MPEG4 format, and audio data in installed HDD format, by using the G-723 compression standard.

- DVR is a digital device that stores video and audio data by using a hard disk drive, unlike a video cassette recorder using video tapes. DVR enables users to easily play back and search stored data, and edit and send data which are stored in digital signal format. Users can compress, store and send moving images, and search listings on an hourly or daily, camera unit and event basis by using this DVR with standard video and data compression technology.







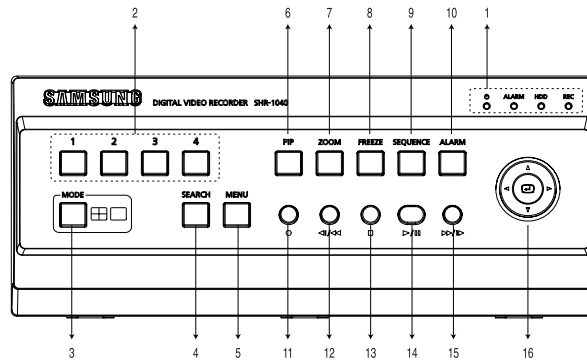

2 Features















- Adjusts recorded data in three steps.
 - HIGH, NORMAL, LOW
- Adjusts the number of record fields per second.
 - NTSC : 1~ MAX 30 IPS
- Records before-event (Alarm or Motion) data based on pre-set hours. (Pre-Alarm)
 - 0 ~ 5SEC
- Audio-records and plays back selected channels.
- Offers a timer used for time record.
- Records video and audio with alarm.
- Offers various playback speeds.
- Offers easy-to-use search functions.
 - Date & Time Search, Event(Record, Alarm, Motion, Timer) Search
- Instantly pauses the current screen. (FREEZE)
- Offers 2X Zoom for video images monitored or played back by the user.
- Offers a variety of screen split modes.
 - Full Screen Display, 4 Split Display, Sequence Display, PIP Display
- Allows the user to enjoy audio and video over a PC monitor through VGA Out.

3 Part Names & Function



[SHR-1040]

No.	Name	Function
①	 Power LED	Displays power On/Off condition.
	 Alarm LED	lights on when an event occurs.
	 HDD LED	Displays Normal Access to HDD. Upon Access to HDD, LED repeats on and off.
	 Rec LED	Displays the record condition.
②	 CH1, CH2, CH3, CH4	The screen is switched to Single Mode when each channel key is pressed during live programming, and the screen of the channel is displayed in Full Screen.
③	 Screen Split Selection Button	During initial booting, the screen is displayed in four split. When the Mode Key is pressed, the screen is switched to single or split screen.
④	 SEARCH	Enters the date/time of video and audio signals recorded in HDD, select events from the RECORD and ALARM EVENT SEARCH, and views the POWER EVENT LIST and LOSS EVENT LIST.
⑤	 MENU	Displays the MAIN MENU, and exits the MENU Screen by pressing the button again.
⑥	 PIP	Enters the PIP Mode when the PIP Button is pressed in the Single Screen. There must be two or more input channels. (1) PIP is enabled when the sequence of the Single Screen (Main Screen) is turned off. (2) The Main Screen moves to Channel 1, 2, 3 and 4 in sequence when the up/down or left/right button is pressed. (3) Main-Sub switching: The screen is switched when the Enter Button is pressed in the PIP Screen while the Sequence is turned off.

No.	Name	Function
7	 ZOOM	You can view X2 screen by pressing the ZOOM Button in the single screen. When you press the up/down and the left/right key in the Zoom screen, the selected Zoom Area moves. Press the Enter button to view X2 Zoom Screen of the selected area.
8	 FREEZE	Press the Freeze Button to freeze the current displayed screen, and press the Freeze Button again to cancel the Freeze. The Freeze marker is displayed on top of the screen in Freeze Mode.
9	 SEQUENCE	When pressing the Sequence Button in the Single Screen, the screen is switched to each channel with video In.
10	 ALARM	When the Alarm Button is selected, the Alarm is canceled.
11	 RECORD	In Normal Record Mode, video signals are recorded.
12	 Fast/Step Reverse	Fast Reverse: Used for fast search in reverse direction playback. Step Reverse: Used for cut-by-cut search in reverse direction during pause.
13	 STOP	Ends search during playback and recording.
14	 PLAY/PAUSE	Operates in toggle for play/pause during playback.
15	 Fast/Step Forward	Fast Forward: Used for fast search in forward direction during playback. Step Forward: Used for cut-by-cut search in forward direction during pause.
16		 Direction key used to set the details of the Menu.
		 Used to increase the value of setting, or direction key used to set the details of the Menu.
		 Direction key used to set the details of the Menu.
		 Used to decrease the value of setting, or direction key used to set the details of the Menu.
		 Plays the role of Enter Key when setting the Menu.

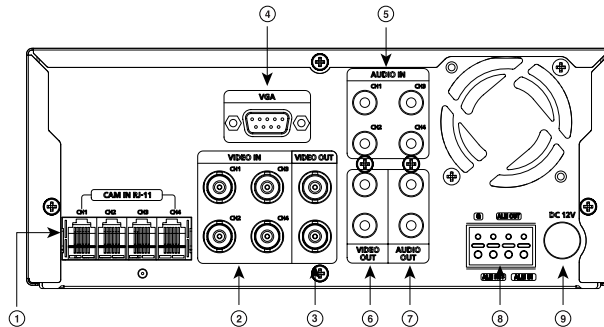

[SHR-1040]

Caution

The ventilation outlet may be blocked. Do not operate the DVR on a carpet or other soft surfaces. When you operate the DVR in a cabinet or on a rack, check whether a ventilation device is properly installed.

No.	Name	Function
①	CAM IN RJ-11	Connector linked to the Port DIY CAMERA.
②	BNC VIDEO IN	Composite video signal input connector (BNC Style Connector)
③	BNC VIDEO OUT	Composite video signal output connector (BNC Style Connector)
④	VGA	VGA video signal output connector
⑤	AUDIO IN	Audio signal input connector (RCA Jack)
⑥	RCA VIDEO OUT	Video signal output connector (RCA Jack)
⑦	RCA AUDIO OUT	Audio signal output connector (RCA Jack)
⑧	ALARM	<ul style="list-style-type: none"> - ALARM IN: Alarm input connector. Receives alarm signals from outside. - ALARM OUT: Alarm output connector. Sends alarm signals to external devices. - ALARM RESET: Alarm reset connector
⑨	DC IN	Supports 12V power socket.

4 Remote Controller

- 1. RECORD**
Starts the recording as the setup record setting in normal record mode.
- 2. ID RESET**
The ID is reset.
- 3. NUMBER KEY**
Press to select one of single channels in Live mode. Use this for typing purposes in a numeric input mode.
- 4. MODE**
Selects split-screen.
- 5. FREEZE**
Runs the FREEZE function in live mode.
- 6. ZOOM**
Press to enlarge the single channel picture to its double.
- 7. ■ (STOP)**
Ends search during playback and recording.
- 8. ◀**
FR (fast reverse) : used for quick backwardsearch while in play.
- 9. MENU**
Either goes to the system menu screen or moves to the upper menu from the lower menu.
- 10. ◻ (ENTER)**
Shows the cursor for the channel selection in live mode or used as the select button for menu setup.
- 11. REC LOCK**
You can check if REC LOCK is set to ON/OFF.
- 12. MONITOR OUT**
You can check which mode is set for the current monitor output.
- 13. CH 1**
Displays SINGLE CH 1.
- 14. CH 2**
Displays SINGLE CH 2.

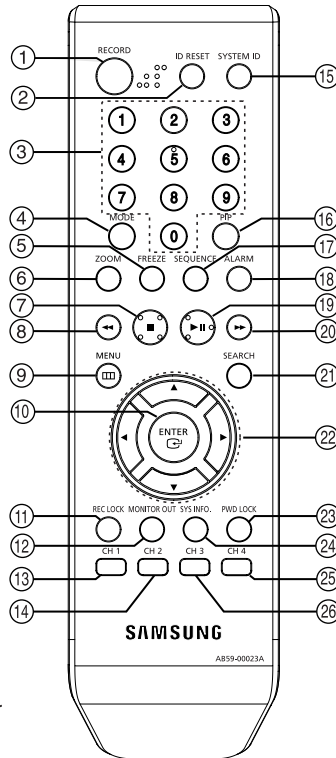

- 15. SYSTEM ID**
Confirms system and remote control ID and changes the remote control ID.
- 16. PIP**
In Single mode, press to watch another channel in a sub picture.
- 17. SEQUENCE**
The single channel mode switches according to the specified time on the menu.
- 18. ALARM**
Cancels the alarm while the alarm is going off.
- 19. ▶ II**
Play/Pause : pauses and resumes the search screen while in play.
- 20. ▶▶**
FF (fast forward) : used for quick forward search while in play.
- 21. SEARCH**
Searches for data on the HDD.
- 22. ▲ ▼ ◀ ▶**
Used for changing settings or for moving the cursor up/down/left/right in live mode and on the menu and search screens.
- 23. PWD LOCK**
You can check if the password lock (PWD LOCK) is set to ON/OFF.
- 24. SYS INFO.**
You can check out information on the system version.
- 25. CH 3**
Displays SINGLE CH 3.
- 26. CH 4**
Displays SINGLE CH 4.

To change the remote control ID

While pressing the SYS ID key, enter the numeric ID in two digits (Default ID: 00).

ex) If you want to change the remote control ID to "08": While pressing the SYS ID key, enter 0 and 8 and press it again to check if the ID is changed to 08.



Chapter 2. Installation

1 Installation Environment Setup

Do not play DVR on the carpet or other soft material to prevent clogging of the air ventilator. To play DVR on the cabinet or rack, be sure to check the ventilation condition.

You should pay attention to the following before you use the product.

- 1. Do not use it outdoor.*
- 2. Do not let water or liquid in the connection part or the product itself.*
- 3. Do not impose excessive shock or force.*
- 4. Do not pull out the power plug unreasonably.*
- 5. Do not disassemble the product on your own.*
- 6. Do not exceed the rated input or output range.*
- 7. Use certified power cord only.*
- 8. Use the power cord with a ground for the product with an input ground.*

2 Checking Product & Accessory

Upon delivery of a product, you shall unwrap the product and put it on the even floor or where you want to use it. Then you shall check if the following items are in it.

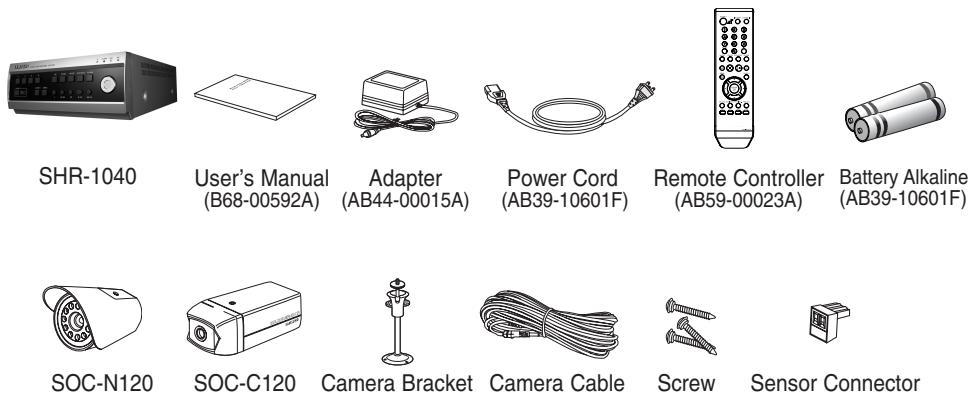

NO	Item	Model	Q'ty	SHR-1040/XAA	SHR-1040K/XAA
1	DVR	SHR-1040	1	0	0
2	User's Manual	-	1	0	0
3	Warranty Card	-	1	0	0
4	Adapter	ADP-5412WD	1	0	0
5	Power Cord	-	1	0	0
6	Remote Controller	-	1	0	0
7	Battery Alkaline	-	2	0	0
8	CAMERA	SOC-N120	2	x	0
9		SOC-C120	2	x	0
10	Camera Bracket	SBR-110S	4	x	0
11	Camera Cable	MCB-60	4	x	0
12	Screw	-	12	x	0
13	Sensor Connector	-	4	x	0

SHR-1040/XAA : No.1 ~ No.7 items are only included.
 WARNING) SHR-1040 set must use the adapter we provide.

3 HDD Addition

You can install one additional hard disk drive inside the product (Max. 2 HDDs). However, there are lots of factors inside that may cause electrical shock, physical damage or malfunction. So please follow the instructions below to mount the HDD as the product couldn't recognize the additionally installed HDD or may not work properly due to incorrect installation or connection.

[Installation Instructions]

- Make sure that any cable should NOT be stuck between components inside and do NOT use an uninsulated cable of which coating is stripped off (Otherwise, it can cause fire or malfunction).
- Any sharp edges inside the product can cause a physical damage during the installation.
- Keep the screws or components removed for HDD addition in a place where you can easily locate them when necessary. Uninstalled screws or components can cause malfunction or inoperability.

[To install an additional HDD]

1. Loosen the screws, two on each side (left/right) and three on the rear, to remove the cover.

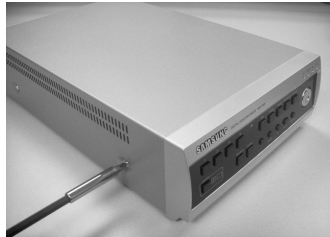

2. Remove the cover.
(Push the cover back before lifting up on the rear side)



3. There is a bracket (BRACKET-HDD) inside for mounting and fixing the HDD.



BRACKET-HDD



5. Disconnect the power supply cable and the signal cable (IDE cable) from the current HDD. Push the bracket to the arrow direction as in the picture below and lift it up from the bottom.

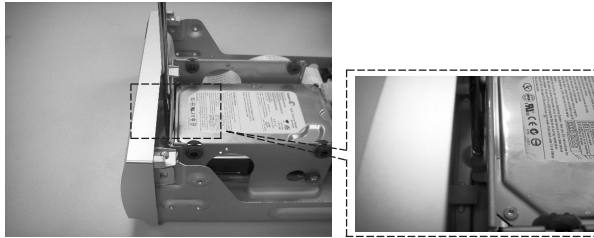

6. Use the four screws provided (SCREW-SPECIAL: PWH,+,-,6-32UNC,L14.7(4.2),ZPC) to fix the old HDD and the additional with the bracket
(Make sure you fasten the screws firmly so that they are not loose from vibration).

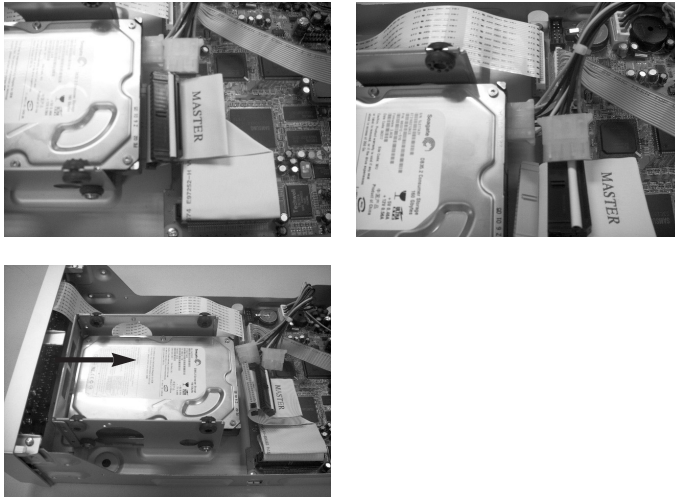

7. Mount the HDD-fixed bracket to its original position. (Installation is done in the reverse order of the disassembly. Fit the bracket (BRACKET-HDD) into the bottom hole and fix the screw).

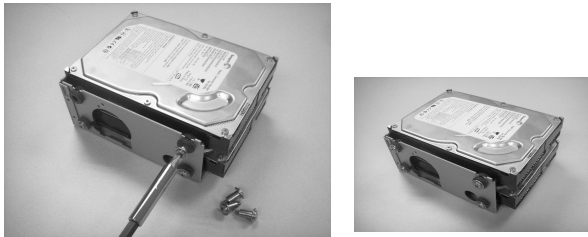

8. When done (make sure the bracket is firmly fixed), connect the power supply cable and the signal cable (IDE) to both the old and the additional HDD (see the picture below).



9. Check if all the connections (connectors) are properly made and firmly fixed, and close the cover.

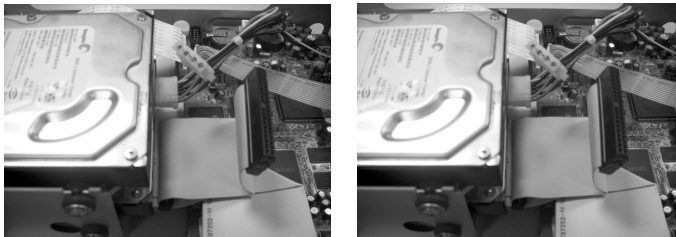

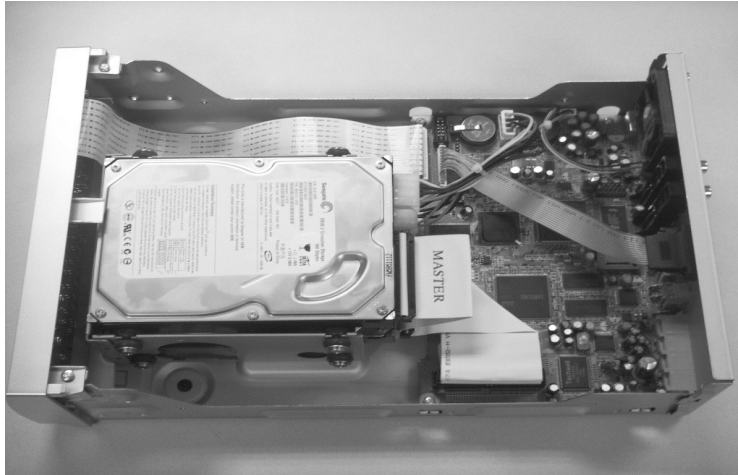

10. Use the screws (two for each side and one for the rear) in step 1 above to fix the cover.





Chapter 3.

DIY Camera

1 Standard Camera

Composition and Installation Method

1) STANDARD CAMERA COMPOSITION (SOC-C120)

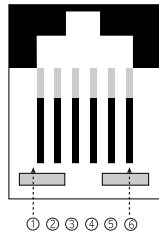
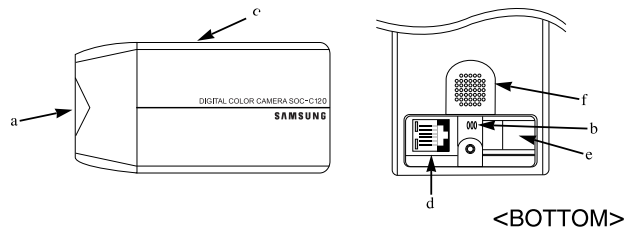

PIN NUMBER	SPEC
①	SPEAKER(HOT)
②	VIDEO-OUT
③	GND
④	SPEAKER(COLD)
⑤	AUDIO-OUT/ALARM-OUT
⑥	18V DC

a. Lens

It has a focal length of 3.8mm and makes it possible for you to observe a relatively wide area.

b. Microphone

Capable of picking up all sound in the vicinity of the camera location and transmitting to the monitor.

c. Camera fitting groove

Enables the camera to be fixed onto the bracket. You may install it either above or below the camera if necessary.

d. 6-pin modular jack

Used to connect the camera to the monitor.

e. SENSOR jack

Used to connect the sensor to the camera.

f. Speaker

Outputs the sound signal.

2) INSTALLING STANDARD CAMERA (SOC-C120)

SOC-C120 camera can be attached to the wall, ceiling or shelf using the camera mount bracket (SBR-110S).

Choose an installation site that can sufficiently support the weight of the equipment to be installed. Attach the camera mount bracket to the wall or ceiling using the supplied three screws (M4 X L15).

Adjust the camera to target the video location and tighten the bracket handle on the camera mount bracket.

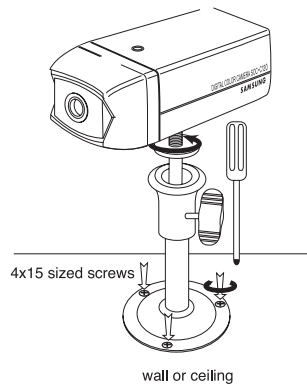

3) CAMERA MOUNT BRACKET(SBR-110) & STANDARD CAMERA(SOC-C120)

(1) Overview

CAMERA MOUNT BRACKET (SBR-110S) is used to attach the camera to a wall, ceiling or shelf.

(2) Specifications

Use : Indoor

Installation : Wall or Ceiling

Dimensions : 2.25 (W) X 1.86(H) X 3.95(L) inches

Weight : 0.29 lbs

Operating Temperature : 32°F ~ 104°F

(3) Accessories

SCREW (M4 X L15) : 3 pcs

(4) Installation

Explains the installation of CAMERA MOUNT BRACKET installation, as well as installation of the camera onto the CAMERA MOUNT BRACKET.

- Choose an installation site that can sufficiently support the weight of the equipment to be installed.
- Attach the camera mount bracket to the wall using the supplied screws (M4 X L15).



- Adjust the camera to target the video location and tighten the bracket handle on the camera mount bracket. Install the camera on to the male screw of the Camera Mount Bracket by rotating the camera in clockwise.

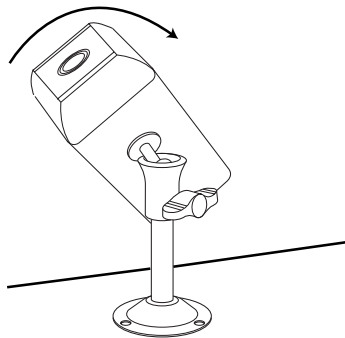

- Loosen the handle by turning it in a counter-clockwise direction and then adjust the camera position . Tighten the handle, turning it clockwise, and lock the camera in position.
- Connect the camera cable to the camera.

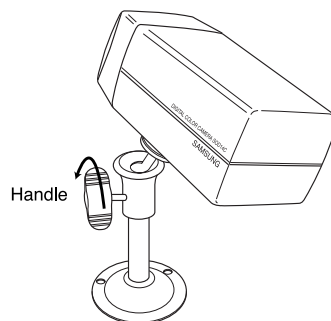

After positioning the monitor and installing four cameras in the desired location, please connect the CAMERA to the DVR using the CAMERA CABLE (MCB-60) as shown in the figure below.

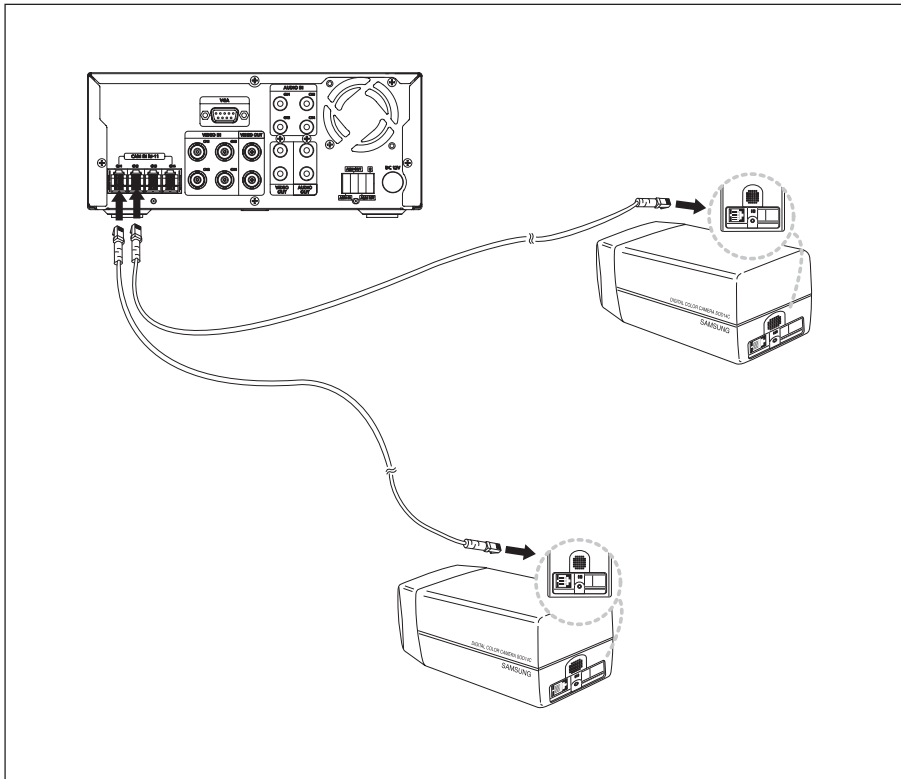

Connection status checking method :

- Turn on the DVR after connecting cameras, and check if camera image is displayed.
- If the DVR and the camera are not connected properly, OSD 'L'(LOSS) will be displayed on screen.

2 Nightvision Camera

1) Before Installation

SOC-N120 INTRODUCTION

SOC-N120 Nightvision camera is intended to be used exclusively with those sold by this company for DIY. With the built-in IR LED and light sensor in the camera, both day monitoring and night monitoring are possible. Also, since it is designed as water-proof daily product, it can be used not only indoors, but also outdoors.

2) Precautions for Installation and Operation

Installing SOC-N120

- * Make sure the installation location is a place where 5 times (about 1 kg) of the total weight of the camera can be tolerated before installing the camera.
- * When installing the camera, make sure the cable is not squeezed in an inappropriate place or the insulation plastic is removed (it will be a cause for malfunction or fire).
- * Keep personnel away from under the installation location because there is a risk of object falling during installation. Move precious items to a safe place as well before the installation.
- * Install SOC-N120 in a cool place where there is no direct sunlight.
- * Do not expose SOC-N120 to direct sunlight during operation or storage.
- * SOC-N120 should always be used in a place where certain temperature and humidity can be maintained (as specified below).
 - Temperature: 14°F ~ 122°F
 - Humidity: Below 90%

3) Installation

1. Make sure the installation location is a place where 5 times (about 2.2lbs) of the total weight of the camera can be tolerated before installing the camera.

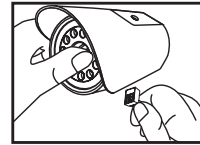
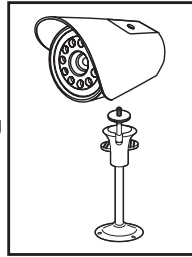

2. Connect the cable below the camera after attaching the provided Mount Bracket to the desired place.

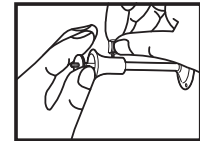
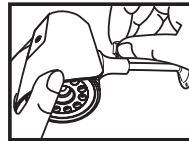

3. Use the handle on the Mount Bracket to adjust the direction you want to setup for monitoring.

SOC-N120 Pin Configuration

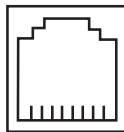

1	SP-
2	VIDEO_OUT
3	GND
4	SP+
5	ALM/AUDIO
6	VDD

4) Title of Each Component

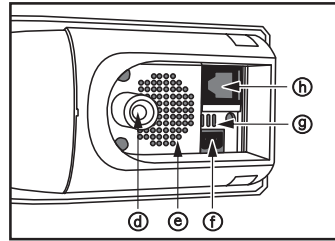
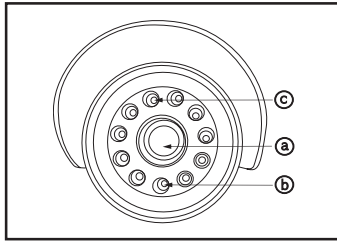

- a). Lens**
- It has a focal length of 3.8mm and makes it possible for you to observe a relatively wide area.
- b). Illumination Sensor**
- Detects incoming light to control the IR LED.
- c). IR LED**
- This is an infrared LED that is controlled by the illumination sensor.
- d). Camera fitting groove**
- Enables the camera to be fixed onto the bracket. You may install it either above or below the camera if necessary.
- e). Speaker**
- Used to connect the sensor to the camera.
- f). SENSOR jack**
- It outputs the sound signal which was transferred from alarm sensor.
- g). Microphone**
- Capable of picking up all sound in the vicinity of the camera location and transmitting to the monitor.
- h). 6-pin modular jack**
- Used to connect the camera to the monitor or DVR.



Chapter 4.

Connecting with other device

1 Connecting the Video, Audio, and Monitor

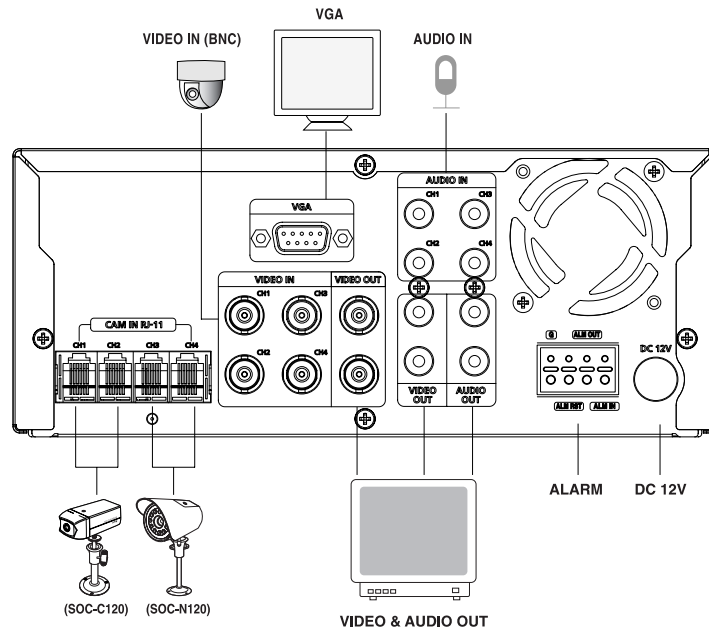

[SHR-1040]

⚠ Caution

- Do not connect the Video In (BNC Input) and the RJ-11 (DIY Camera) input with the same channel at the same time. If connecting them simultaneously, two input signals may be mixed when outputting. This is not the product defect; so, please connect only one between the two inputs.
- When the first delivery, the Video output is set to the CVBS (BNC Output) output. If viewing on the VGA Monitor, set it in the MENU first. (Refer to 6-12 page)
- The same Video signal is outputted for the BNC Out and the RCA Out of the Video out. Use by connecting the desired port.

2 Connecting the Alarm Input/Output

The Alarm IN/OUT port in the back of SHR-1040 is composed of the following elements.

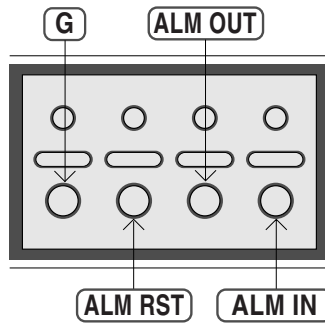

- ALARM IN/OUT Connection

	Name	Function
1	ALM IN	ALARM Input Port
2	ALM OUT	ALARM Output Port
3	ALM RST	On receiving an ALARM RESET signal, the system cancels the current ALARM input and output signal and then resumes sensing.



Chapter 5.

Basic Operation

1 System Operation

Turning Power On

- When the adapter is connected to the DC 12V connector on the back panel, the Power LED on the front is lit. The following screen appears, and the system is booted.



Detection of Video In Signals

- If no video signals exist when the system is turned on, the letter L (for Loss) appears next to the title (CAM1...CAM2) of the screen, and the screen turns black. Connect a video signal, and the letter L will disappear. You can check the Video Loss Event on the Loss Event List of the Search Menu.

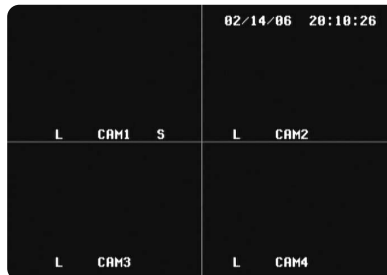

2 Live Screen Mode

Full Display Screen

Markers and displays on the screen are seen as below.

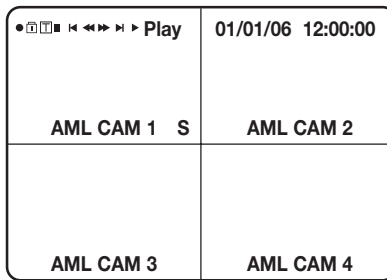

05/05/01 00:00:01	For Live, it indicates the current time and date as set in the system. For playback, it indicates the time and date of the data recording.
●	marker is displayed when the system in recording mode.
☐	Prevents the cancellation of REC.
▶ PLAY	Indicates playback at normal speed.
	Indicates pause.
◀◀2	Indicates X2 reverse playback.
◀◀4	Indicates X4 reverse playback.
◀◀8	Indicates X8 reverse playback.
◀◀16	Indicates X16 reverse playback.
◀◀32	Indicates X32 reverse playback.
◀◀64	Indicates X64 reverse playback.
▶	Indicates X1 forward playback.
▶▶2	Indicates X2 forward playback.
▶▶4	Indicates X4 forward playback.
▶▶8	Indicates X8 forward playback.
▶▶16	Indicates X16 forward playback.
▶▶32	Indicates X32 forward playback.
▶▶64	Indicates X64 forward playback.
▶	Used for cut-by-cut search in reverse direction during pause.
◀	Used for cut-by-cut search in reverse direction during pause.
A	A marker appears when the system is in Alarm recording mode.
L	Indicates the VIDEO LOSS state.
M	M marker appears when the system is in Motion record mode.
T	T marker appears when the system is in Time record mode.

3 Key Functions

1. CHANNEL KEY & MODE KEY



- Use the CHANNEL Key when you want to view the channel in full screen.
- Press the desired channel key to view the channel in full screen.
- Audio of the channel is also selected. The S mark appears next to the title of the selected channel, and the audio of the channel is off.
- Audio recording is available for the one selected channel.
- Press the MODE Key to view the 1CH MODE and the QUAD MODE in turn as shown in the picture.

2. PIP KEY



- Use the PIP Key to view the main and the sub screen at the same time.
- You can view the two channels when pressing the PIP button in the 1CH mode.
- Press the ENTER Key in PIP mode to switch the main and sub screen.
- Press the PIP Key again to exit the PIP state and enable the Single screen mode.
- Press the FREEZE Key to freeze the main screen only. On the top right of the screen, '||' (FREEZE MARK) appears.
- Clear the Freeze before operating another key.
- Press the Sequence Key in the PIP mode PIP to automatically sequence to the sub screen. (Auto sequence is cleared when pressing the Sequence Key again.)
- Sequence in the PIP MAIN CHANNEL 1 screen
SUB2 → SUB3 → SUB4 → SUB2

3. ZOOM KEY



- The ZOOM Key is used to X2 zoom the selected area in 1CH mode.
- Press the ZOOM Key to display the ZOOM area (default: Center Area).
- Press the ZOOM Key repeatedly to display or clear the ZOOM area.
- Press the ZOOM Key to zoom the selected area, and press the ENTER key to clear the ZOOM and display the marked area.
- ZOOM function is operated in the Single screen mode. SINGLE.

4. FREEZE KEY



- The FREEZE Key is used to pause the screen.
- Press the Freeze Key to display the 'II' marker on the top right. The screen is paused. Press the Freeze Key again to make the 'II' marker disappear and clear the pause screen.

5. SEQUENCE KEY



- The Sequence Key is used for automatic channel sequencing. It is enabled only in Live Mode.
- Channels are switched in sequence and the Loss channel without video signals are skipped during the Dwell Time set by the Setup Menu.
(Switch from 1channel → 2 channel)
- Sequence in the Full Screen
CH1 → CH2 → CH3 → CH4 → CH1 → CH2 → CH3 → CH4 →
- Sequence of the Main Channel 1 in the PIP Screen
SUB2 → SUB3 → SUB4 → SUB2 →

6. ALARM KEY

- Cancel the alarm when alarm is enabled.



Chapter 6. Menu Setup

1 Main Setup Menu

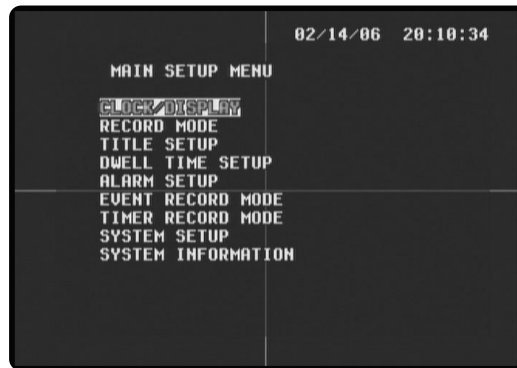

1. CLOCK/DISPLAY
 - Set the time, date and display items.
2. RECORD MODE
 - Set record-related items.
3. TITLE SETUP
 - Set channel titles.
4. DWELL TIME SETUP
 - Set the dwell time for each channel for sequence operations.
5. ALARM SETUP
 - Set the alarm channels and setup/alarm-related items.
6. EVENT RECORD MODE
 - Set the recording and motion detection items when the alarm is on.
7. TIMER RECORD MODE
 - Set the time record.
8. SYSTEM SETUP
 - Set the initiation of the system and the password.
9. SYSTEM INFORMATION
 - Displays the HDD capacity and the system software version.

2 Clock/Display Setup

- Set the time, date and display items.

CLOCK/DISPLAY SETUP	
DATE TYPE	MM/DD/YY
DATE	02/14/06
TIME [HH:MM:SS]	20:10:42
DATE/TIME	ON
STATUS	ON
BORDER	ON
BORDER COLOR	GRAY
PIP POSITION	B-RIGHT

(1) DATE TYPE

- Date can be displayed in three types, and the user can choose one among the three.
[YY/MM/DD, MM/DD/YY, DD/MM/YY]

(2) DATE

- Set the present data.

(3) TIME [HH:MM:SS]

- Set the present time.

(4) DATE/TIME

- Set the date/time to "On" to display it on the screen, set the date/time to 'Off' to not display it.
[ON/OFF]

(5) STATUS

- Set the system status 'On' to display playback information when record or play back recorded video, and set the status to 'Off' to not display such information.
[ON/OFF]

(6) BORDER

- Display or hide the border of the screen. Set the border to 'On' to display the border, and set the border 'Off' to not display the border.
[ON/OFF]

(7) BORDER COLOR

- The border color can be defined in three colors.
[GRAY/WHITE/BLACK]

(8) PIP POSITION

- Set the location of the sub screen.
[B-RIGHT/B-LEFT/T-RIGHT/T-LEFT]

3 Record Mode Setup

RECORD MODE SETUP	
02/14/06 20:10:48	
PICTURE QUALITY	NORMAL
PICTURE RATE	15 IPS
DISK END MODE	STOP
DISK END ALARM TONE	ON
RECORD TIME MARK	ON
RECORD TITLE MARK	ON

- (1) **PICTURE QUALITY**
 - Define the picture quality in three steps when recording. High means top quality, followed by Normal and Low.
 - [NORMAL/HIGH/LOW]**
- (2) **PICTURE RATE**
 - Set the number of record fields for video In.
 - [1/2.5/3.75/7.5/15/30]**
- (3) **DISK END MODE**
 - When the mode is set to Stop, recording is stopped if the HDD becomes full during recording.
 - When the mode is set to Continue, new data overwrites previously recorded data during recording. The oldest data saved will be overwritten first.
 - [CONTINUE/STOP]**
- (4) **DISK END ALARM TONE (HDD-full alarm mode)**
 - When the Disk End mode is set to Stop, the alarm tone rings if the HDD becomes full during recording if the tone is 'On.' The alarm tone does not ring if the tone is 'off'. The tone is enabled when the Disk End Mode is set to Stop.
 - [ON/OFF]**
- (5) **RECORD TIME MARK (Record time display)**
 - When the mark is set to 'On', the time of recording is displayed during playback. When the mark is set to 'Off', the time is not displayed.
 - [ON/OFF]**
- (6) **RECORD TITLE MARK (Record title display)**
 - When the mark is set to 'On,' the title of recording is displayed during playback. When the mark is set to 'Off,' the title is not displayed.
 - [ON/OFF]**

4 Title Setup

- The default settings of the title setup menu are shown as follows.

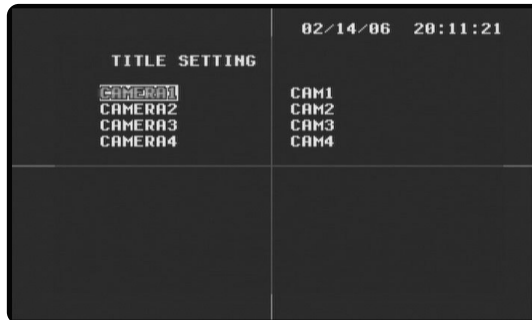

(1) TITLE SETUP

- You can set the title of each channel as you want.
- You can change the title by using ▲, ▼, ◀, ▶, [↵]

```
0 1 2 3 4 5 6 7 8 9
ABCDEFGHIJKLMNOPQRSTUVWXYZ
: = . ( ) [ / ] _ + - █
```

- Place the cursor on the "█" area when the title is not displayed. Press Enter to delete OSD.

5 Dwell Time Setup

- The default settings of the Dwell Time are shown as follows.

DWELL TIME SETTING	
CAM1	03 SEC
CAM2	03 SEC
CAM3	03 SEC
CAM4	03 SEC

(1) DWELL TIME SETUP

- Press the Sequence button in single screen to enter Sequence Mode. You can set the dwell time of each channel before switching.

When the Dwell Time is set to 0 seconds, the channel is skipped and the next channel appears.

[0SEC, 1SEC, 2SEC, 3SEC..... ~ 60SEC]

6 Alarm Setup

- The default settings of the Alarm Setup Menu are shown as follows.

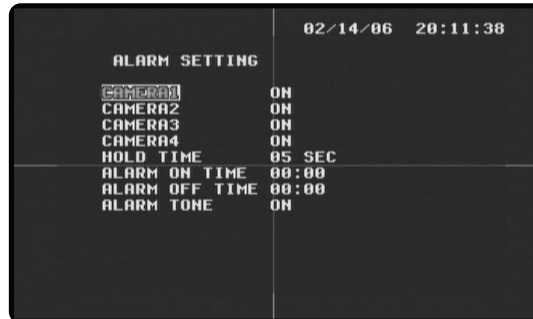

ALARM SETTING		02/14/06 20:11:38
CAMERA1	ON	
CAMERA2	ON	
CAMERA3	ON	
CAMERA4	ON	
HOLD TIME	05 SEC	
ALARM ON TIME	00:00	
ALARM OFF TIME	00:00	
ALARM TONE	ON	

(1) ALARM SETUP

- Set the alarm setup to 'ON' to enable the alarm of each camera. Set the setup to 'OFF' to disable alarm. [ON/OFF]

(2) HOLD TIME

- When Alarm occurs, set the hold time of alarm.
[5SEC, 6SEC, 7SEC, 8SEC ~ 59SEC, 1MIN, 2MIN, 3MIN ~30MIN]

(3) ALARM ON TIME

- Set the start time of alarm operation. When the ALARM ON TIME and the ALARM OFF TIME are set, alarm is detected during the period.
[00:00~23:59]

(4) ALARM OFF TIME

- Set the end time of alarm operation.
[00:00~23:59]

(5) ALARM TONE

- When the ALARM TONE is set to 'ON', the Alarm Tone rings when alarm is detected.
[ON/OFF]

7 Event Record Mode Setup

- The default settings of the Alarm/Motion Recording Setup menu are shown as follows.

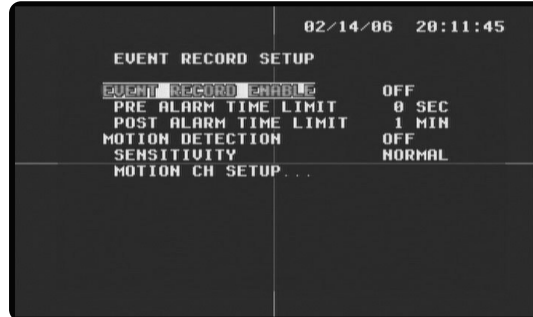

(1) EVENT RECORD ENABLE

Set the EVENT RECORD ENABLE to 'On' to start recording when alarm occurs, and set the EVENT RECORD ENABLE to 'Off' to not start recording when alarm occurs. If you exit the menu after setting the EVENT RECORD ENABLE to 'On', the system records data whenever an alarm occurs.

The following screen shows that the system records a program after an alarm occurs. The 'A' mark before the title of the channel indicates that an alarm occurred.

[ON/OFF]



(2) PRE ALARM TIME LIMIT

- The Pre Alarm Time Limit enables users to know the state of the system before a motion is detected or an alarm occurs. It decides the length of time for recording video and audio data input right before motion or alarm. The system always stores 0 to 5second-long video and audio data in the memory, and records data during the pre-set time set by the Time Limit in HDD when alarm recording starts.
[0, 1SEC, 2SEC, 3SEC, 4SEC, 5SEC]

(3) POST ALARM TIME LIMIT

- After recording data as set by the MAIN ALARM TIME, the system records additional seconds as set by the POST ALARM TIME Limit.
[10SEC ,20SEC ,30SEC ,1MIN ,2MIN ,3MIN ,4MIN , 5MIN]

(4) MOTION DETECTION

- When the Motion Detection is set to 'ON', the system records input video whenever a motion is detected.

[ON/OFF]

(5) SENSITIVITY

- You can set the level of sensitivity of motion detection when setting motion detection. HIGH/NORMAL/LOW. High indicates the highest level of sensitivity of motion detection, and Low indicates the lowest level of sensitivity of motion detection.

[HIGH, NORMAL, LOW]

(6) MOTION CH SETUP

- Set the channel from which a motion is detected.

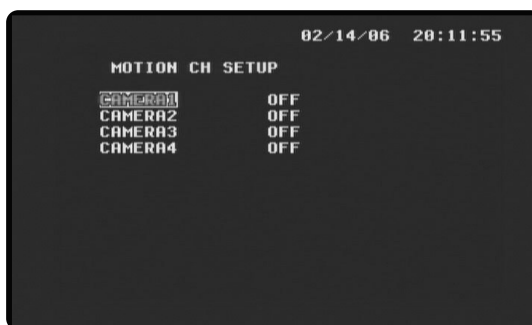

- You can divide the motion detection area into total 9 for each channel.

The following screen displays to activate only No. 1 area of No. 1 channel. You can use the direction key to move the area around and select FULL for the motion detection on the whole screen.

With MOTION DETECTION set to ON, if no motion is detected in the specified area while a motion is sensed in other areas, MOTION DETECTION will not operate.



- Motion is detected only from channels set to 'On.'
- The following screen shows motion recording after motion detection. A motion is detected in the Channel 1. The 'M' mark before the title of each channel indicates that a motion is detected.
- [ON/OFF]



8 Timer Record Setup

TIMER	DAY	START	END	FIELD RATE
OFF	---	---	---	---
OFF	---	---	---	---
OFF	---	---	---	---
OFF	---	---	---	---
OFF	---	---	---	---
OFF	---	---	---	---
OFF	---	---	---	---
OFF	---	---	---	---

- (1) **TIMER:** Set the Timer to 'On' to enable timer recording. [ON/OFF]
- (2) **DAY:** Set the day of the week to record data.
[MON, TUE, WED, THU, FRI, SAT, DAILY, SUN]
- (3) **START & END:** Set the start and ending time of recording. [00:00~23:59]
- (4) **FIELD RATE:** Set the number of fields to record per second.
[1/2.5/3.75/7.5/15/30]

9 System Setup

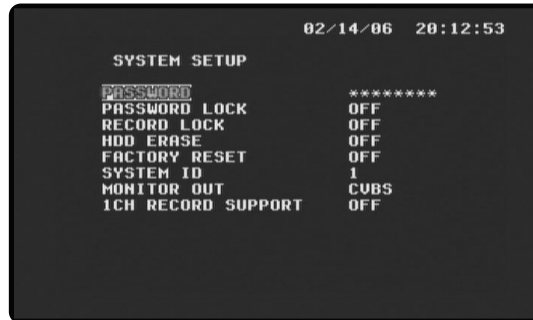

(1) PASSWORD

- The default password : 4321

- You can set the password to limit access to the Main Screen setup by unauthorized people.

(Create a four-digit password by choosing between 1-4.)

You can enter the password from No. 1 to No. 4 using the corresponding channel key.

Once the password is entered, you'll see the following message that asks if you want to change the password. If you want to change it, click OK and if not, click CANCEL.

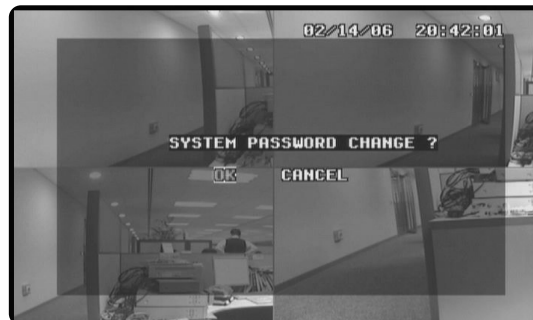

(2) PASSWORD LOCK

When the user sets the Password Lock after setting a password, he or she has to enter the password whenever entering the menu.

[ON/OFF]

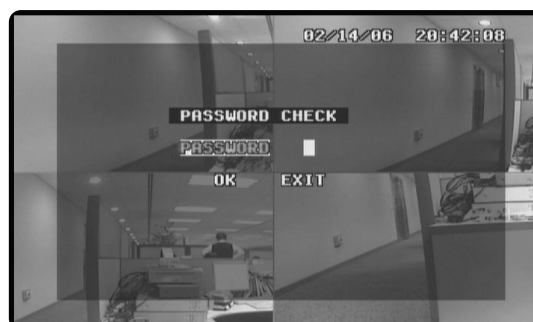

(3) RECORD LOCK

If you set RECORD LOCK to ON and press STOP to release the current recording, you are prompted to enter the PASSWORD.

(4) HDD ERASE

If you exit the Menu after setting HDD ERASE to ON, you will see the following message that asks if you want to erase the data on the HDD. If you click OK, you'll see "HDD ERASE" as in the next picture, and the existing HDD Data is erased. If you click CANCEL, the HDD data will not be erased.

[ON/OFF]

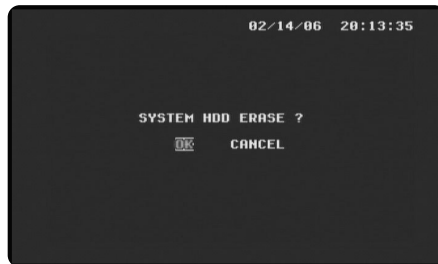

! Caution

Deleted data cannot be restored. Check data carefully again before deleting data.

(5) FACTORY RESET

When FACTORY RESET is enabled, the settings are reset to the factory default.

If you exist the menu after setting FACTORY RESET to ON, you'll see the following message that asks if you want to perform FACTORY RESET. If you click OK, the settings are reset to the factory default with a message of "FACTORY RESET" as in the next picture. If you click CANCEL, FACTORY RESET will not perform.

[ON/OFF]

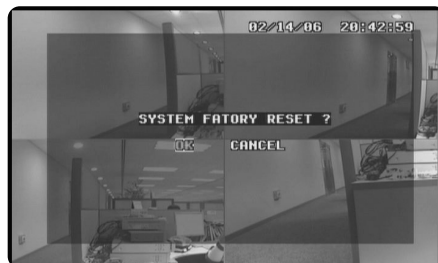

(6) SYSTEM ID

Set the System ID to use the Remote Controller.

When using more than one unit of the system, a number of systems may be operated at the same time with a single remote controller. Set the different IDs for different units.

Press the System ID of the Remote Controller and use the number keys to create IDs.

After the setting, systems with IDs that correspond to the ID of the remote controller will operate.

[0,1,2 ~ 8,9]

(7) MONITOR OUT

Selects the Video Out of the System.

When the Video Out is set at CVBS, the video out is sent through BNC and RCA Video Output port.

When the Video Out is set at VGA, the video out is sent through VGA Video Out port, and seen on the PC monitor. After changing the settings and exiting the menu, the system is automatically rebooted.

After rebooting, the change is applied.

[CVBS/VGA]



(8) 1CH RECORD SUPPORT

If you set 1CH RECORD SUPPORT to ON, the system switches from 4-channel to 1-channel mode.

Then, a selected channel will be the number 1 channel.

If you exist the menu after setting 1 CH RECORD SUPPORT to ON, you will see the following message that asks if you want to change the SYSTEM into 1 channel mode. If you click OK, the system switches.

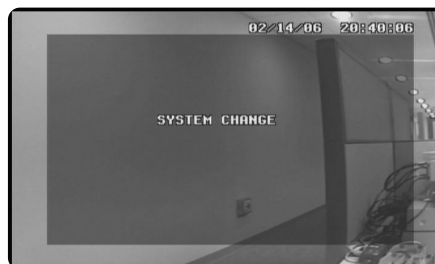
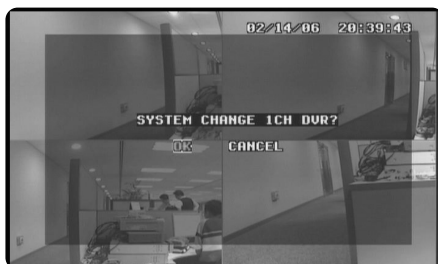

Once the system switched to 1 channel mode, all system functions operate in 1 Channel mode and the items of other channels in the MENU are deactivated.



Once the system switched to 1 channel mode, you can just play the data in this mode and the data recorded in 4 Channel mode could not be played. On the contrary, in 4 Channel mode, the data recorded in Channel 1 mode will not be run and only the data recorded in 4 Channel can be played.

If you want to switch from 1 channel mode back to 4 channel mode, set 1CH RECORD SUPPORT to OFF and exit the MENU. Then, you will see the following message that asks if you want to switch the system mode. If you click OK, the system will be switched.



Note

The hidden key is a shortcut key that is used in the following cases:

- If you have set the password lock but don't remember the password, so that you couldn't access the menu.
- If the current settings of MONITOR OUT does not match those of the current monitor connected, so that you couldn't see the display.

Press and hold down one of the hidden keys below for 5-10 seconds to activate it.

1. **MODE KEY + CH1: MONITOR OUT** Changes the settings of MONITOR OUTPUT. Once the settings are changed, the system automatically reboots. Connect the monitor that matches the changes of the settings.
2. **MODE KEY + CH2: FACTORY RESET**
The system settings are all reset to the factory default. If you press this hidden key under the password lock, the password lock will be set back to OFF (default) and you can access the menu.
3. **MODE KEY + CH4 + ZOOM: FACTORY RESET + HDD ERASE**
The system settings are all reset to the factory default, and data stored on the HDD are all erased. Note that all data on the current HDD will be erased if you press these buttons.

10

System Information

```
06/03/28 09:53:38
SYSTEM INFORMATION
HDD NO      1 EA
CAPACITY    22.65/160 GB
VERSION     SHR-1040 0.46

CAPACITY : USED SIZE/TOTAL SIZE
```

(1) HDD NO

Displays HDD quantity that is installed on the system.

(2) CAPACITY

Displays the HDD capacity of the System.
[Remaining Capacity/Entire HDD Capacity]

(3) VERSION

Displays the version of the System.



Chapter 7. Recording

1 Basic Recording

Press the Record button (●) to record live video. The Rec LED is lit, and the (●) mark appears on the screen. The HDD LED blinks, indicating that data is being recorded to the HDD.



Note

You cannot record previously recorded data now being played back. To record the data, you must stop the playback of the data first.

2 Timer Recording

- You can set the time and date of recording. From the menu list, enter the day of the week (Mon. to Sun. or daily) and the time in the TIME RECORD MODE.
- Recording starts and proceeds on the scheduled time and date for the specified hours.



Note

Enter the Time Record Mode from the Menu screen, and set On/Off before setting the time and date of recording. You can also set the number of fields to be recorded per minute.

3

Motion Recording

Start recording when a motion is detected in the channel and area set by the Alarm/Motion Record Setup menu. When the motion record begins, the M mark is displayed next to the channel, indicating recording is on.



Note

- To enable the motion detection, you have to set an area for each channel. MOTION DETECTION operates only if there is a motion detected in the area of the channel you have selected.

4

Alarm Recording

The Alarm In connector is located in the external in/out port of on the back panel of the system. You can connect the connector with an external device. Then, set the EVENT RECORD ENABLE 'On' in the EVENT RECORD SETUP menu to start recording when an alarm occurs. When recording starts, the following screen appears.



⚠ Caution

Recording stops when the connection with input video signals is interrupted during recording. The system starts recording again when connection to input signals is restored. The system does not start recording when video signals are not connected to the Video In end.

5 Stop Recording

- Click the Stop button to stop data recording.
The REC mark disappears as follows, and recording is stopped.
To stop data recording, click the STOP button.
The REC mark disappears and the current recording stops as shown in the picture. However, if RECORD LOCK is set to ON, you have to enter the password to stop recording.





Chapter 8.

Search & Playback

1 Search Menu

- **Search Menu**

Press the Search button in Live mode to search recorded data.

The following screen appears.

Search is not enabled during recording. Stop recording to start search.

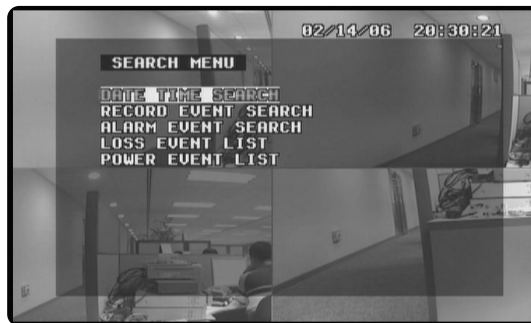

- **DATE & TIME SEARCH** : Search recorded data based on the time and date.
- **RECORD EVENT SEARCH** : Searches for all data recorded in Normal Record or Timer Record.
- **ALARM EVENT SEARCH** : Search all the data recorded in the Alarm/Motion mode.
- **LOSS EVENT LIST** : Display information on the channel and time at the time of Video Loss.
- **POWER EVENT LIST** : Display information on On/Off time of power.

- **Menu Operation**

Move to the menu items by using the left/right and up/down buttons (◀, ▶, ▲, ▼). The selected item is highlighted and displayed with the cursor. Press the Select button to enter the sub menu. In the sub menu, you can enter conditions for data search or select from the list of the recorded data to play back data you want.

- **Enter Search Conditions & Select from the List**

Time & Data Search Enter the conditions for data search in the menu, and press the select button. You can either enter the conditions or select from the list as in the general menu.

- **Move Up To Menu or End Search/Playback**

To move up from the sub menu or end search, press the Menu button. To end playback after selecting data search, press the Search Key and exit through the Live screen.

Warning

The current time and date is displayed in the Time and Date section of the Time/Date Menu. Search recorded data by entering the time and date you want.

The list is not available in the Event Search menu at default, since data is not stored on the HDD.

2 Date Time Search



- (1) **DATE[YY/MM/DD]**
Set the date (year/month/day) you want to search.
- (2) **TIME[HH:MM:SS]**
Set the time you want to search.
- (3) **SEARCH START**
Enter the year/month/day/hour/minute/second you want to search.
Press the Enter button () to search the time and date.

3 Record Event Search

- The following screen appears when selecting the Record Event Search after pressing the Search button.

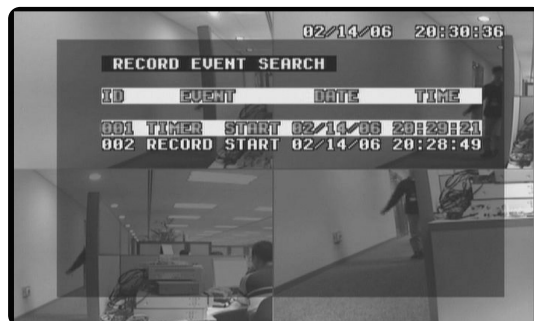

- Displays the list of the data recorded in NORMAL RECORD or TIMER RECORD out of all data on the HDD.
Select from the Record Event List by using up/down left/right buttons (▲, ▼, ◀, ▶). Press the Search button after selecting from the Record Event List to start search.

4 Alarm Event Search

- The following screen appears when selecting the Alarm Event Search after pressing the Search button.



ID	EVENT	DATE	TIME
001	MOTION START	02/14/06	20:28:09
002	MOTION START	02/14/06	20:27:57
003	MOTION START	02/14/06	20:27:01
004	MOTION START	02/14/06	20:26:56
005	MOTION START	02/14/06	20:26:37
006	MOTION START	02/14/06	20:26:02
007	ALARM START	02/14/06	20:24:56
008	ALARM START	02/14/06	20:24:48
009	ALARM START	02/14/06	20:24:29

- Displays the list of the data recorded in ALARM or MOTION RECORD out of all data on the HDD.
Select from the Record Event List by using up/down left/right buttons (▲, ▼, ◀, ▶). Press the Search button after selecting from the Alarm Event List to start search.

Note

Enter the Time Record Mode from the Menu screen, and set On/Off before setting the time and date of recording. You can also set the number of fields to be recorded per minute.

5 Loss Event List

- Display the channel and the time and data at a time of Video Loss.



NO	CH	MM/DD/YY	HH:MM:SS	EVENT
01	03	02/14/06	20:31:20	LOSS
02	02	02/14/06	20:31:20	LOSS
03	04	02/14/06	20:31:14	LOSS
04	01	02/14/06	20:31:06	LOSS
05	01	02/14/06	20:17:20	LOSS

- You can view the list on the following page by using the up/down/left/right buttons (▲, ▼, ◀, ▶).

6

Power Event List

- Display the list of the time and date record of Power On/Off.

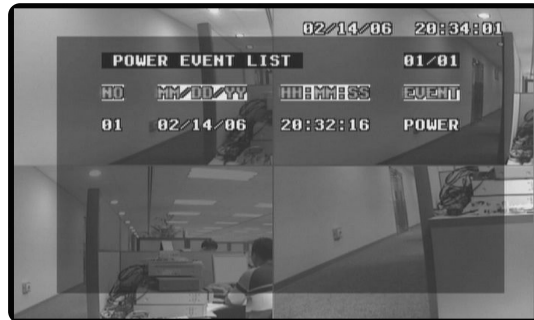

- You can view the list on the following page by using the up/down/left/right buttons (▲, ▼, ◀, ▶).

Note

Enter the Time Record Mode from the Menu screen, and set On/Off before setting the time and date of recording. You can also set the number of fields to be recorded per minute.

7

Basic Playback

- Press the Play/Still Button to play back the recorded data on the HDD. The following screen appears and playback starts. You cannot play back data during recording. You must stop recording and play back data in Live mode.



- The 'No Data' message is displayed when there is no recorded data.

Note

Enter the Timer Record Mode from the Menu screen, and set On/Off before setting the time and date of recording. You can also set the number of fields to be recorded per minute.

- When the system reaches the end of the HDD during playback or the end of the current data, the system will start playing back from the beginning of the first data on the HDD.
- When pressing the Play/Still button during playback, the following screen appears and the screen is in Still mode.



- If you press FAST FORWARD or FAST REWIND button (◀, ▶) during playback, the system plays the data fast forward or fast in reverse, respectively. FAST FORWARD is available in 2X, 4X, 8X, 16X, 32X, and 64X and FAST REWIND, -2X, -4X, -8X, -16X, -32X, and -64X.
- When pressing the FAST FORWARD or FAST REWIND button (◀, ▶) during Still, the system plays back data cut-by-cut in reverse and forward.
- If you press the FAST FORWARD (▶) button during normal playback, the playback speed increases forward. While you press the FAST REWIND (◀) button, the playback speed increases in reverse.



- To restart playback, press the Play/Still button.



Chapter 9. Appendix

1 Product Specification

1) SHR-1040, SHR-1040K

Block	Function	SHR-1040	SHR-1040K(DIY Kit)	etc
Video	Signal Format	NTSC		
	Video Input	4 BNC, 4CH(RJ-11 DIY Camera)		
	Video output	2 BNC, 2RCA, 1VGA		
	Display Mode	1ch - FullScreen, Quad, Sequence, Freeze, Zoom, PIP		
Audio	Display Resolution	720*480		
	Audio Input	4CH(RCA), 4CH(RJ-11 DIY Camera)		
REC/Play /Searching	Audio Output	2 CH(RCA)		
	Video REC/PB Speed	1CH mode : 30IPS 4CH mode : 120IPS		
	Video CODEC	MPEG4		
	Audio CODEC	G.723		
	Simplex/Duplex	Simplex		
	Video REC CH Number	1CH Mode, 4CH Mode		
	Display Speed	4 CH Realtime		
	REC Mode	Time Lapse, Event(Alarm,Motion), Schedule (Date/Time)		
	Play Speed	-64, -32, -16, -8, -4, -2, 1, 2, 4, 8, 16, 32, 64		
	Frame Advance	Forward/Reverse		
	Recording Capability Time	200hours(4CH Real time) 500hours(1CH Real time) Time Lapse Mode : Max 15000hours		
	Video Record Resolution	704*240		
	REC File Size	High : 14KB, Normal : 6KB, Low : 3KB		
	Event List	Record Event, Alarm/Motion Event, Power, Loss CH		
	Search Mode	Recod Event Search, Alarm/Normal Event Search, Date/Time Search		
	Alarm/Motion	Input	1(Terminal Jack), 4(RJ-11 DIY Camera)	
Output		1(Terminal Jack)		
Alarm Reset		1(Terminal Jack)		
Pre Alarm		OFF, 1sec, 2sec, 3sec, 4sec, 5sec		
Duration		5sec ~ 59sec, 1M, 2M ~ 30M		
Buzzer		O		
Motion Det.		9 area / CH		
Motion Detection Level	High, Middle, Low			
Remocon	Password	on/off		
	Remocon	O		
Storage	HDD	160G(MAX HDD SIZE : 250GB * 2)		default 1EA
Power	AC Input	AC100 ~ 240, 2A, 50/60Hz		
	Adapter	DC 12V, 4A		
	Camera Power Output	RJ-11 Jack, DC 12V, 4W * 4		
SET	SHR-1040	1EA	1EA	
	SOC-C120	X	2EA	
	SOC-N120	X	2EA	
Operation Temp.		32°F ~ 104°F		
Preservation Temp.		-4°F ~ 140°F		
Operation Humidity		20% ~ 85% RH		
Preservation Humidity		20% ~ 85% RH		
Size (INCH)		8.46(W) X 3.46(H) X 13.27(D), (Packing) 17.95(W) X 7.20(H) X 13.30(D)	8.46(W) X 3.46(H) X 13.27(D) (Packing) 17.95(W) X 11.5(H) X 13.3(D)	
Weight (LBS)		6 lbs, (Packing) 9.26 lbs	6 lbs, (Packing) 17.42 lbs	

2) SOC-C120 : Standard Camera

Model Name	SOC-C120
Broadcasting System	NTSC STANDARD
Imaging Device	1/4" SUPER HAD (Hole Accumulation Diode) IT CCD
Effective Pixels S	510(H) x 492(V)
Synchronization	Internal
Resolution	H :330 TV Lines, V: 350 TV Lines
Signal Output	VBS 1.0Vp-p(75ohms composite)
S/N Ratio	≤ 48 dB
Minimum Scene Illumination	2lux(F2.0, 50 IRE)
Gamma Correction	0.45
Lens	Focal Length (f) : 3.8 mm, F Number = 2.0
Auto Exposure	Electronic Shutter Iris
Audio	-40dB Condenser Microphone Inclusion
I/O Connectors	Modular jack
Operating Temperature	+32 °F ~ +104 °F
Power Source	DC 12V
Power Consumption	Approx. 2W
Dimensions	2.25(W) x 1.86(H) x 3.95(L) inch
Weight	0.29 lbs

3) SOC-N120 : Nightvision Camera

Model Name	SOC-N120
Product type	IR LED Day &Night Vision Camera
Power source	Voltage DC 12V from Equipment(DIY Monitor or DVR)
Broadcast System	NTSC Standard Color Camera
Image Device	1/4 inch IT S-HAD CCD
Effective Pixel	510(H)x492(V)
Scanning Method	525lines 2 : 1 Interlace
Line Frequency	Horizontal : 15,734Hz Vertical : 60Hz
Weather Resist Grade	IP43
Synchronization Method	INT
Resolution	330TV lines
S/N Ratio	48dB
Light Condition	Light sensor Auto Switching IR LED Control 10pcs
Minimum scene Illumination	Normal : 2 Lux Night mode : IR LED ON
Color Temperature	ATW
Electronic shutter	ELC
Signal Output	Composite Video out 1.0Vp-p 75 ohms RJ11
Lens	Focal length : 3.8mm Aperture(F) : F2.0
Operating Temperature	-10°C~ +50°C
Operating Humidity	~90%
Physical Size	2.51(W) X 2.44(H) X 4.92(L)inch
Weight	0.33 lbs

2

Recommended HDD List

MAKER	MODEL	CAPACITY	REMARK
SAMSUNG	SV0802N	80GB	
	SV1604E	160GB	
	SV2041N	200GB	
WesterN Digital	WD1600JB	160GB	
	WD2500JB	250GB	
Maxtor	6L160PO	160GB	
	6L200PO	200GB	
	6L250RO	250GB	
Seagate	ST3160212ACE	160GB	Attached model in shipment
	ST3250823A	250GB	

3 Outline Drawing

